

Digital Temperature Controllers E5GN

Intelligent Temperature Controllers in Compact Size 1/32 DIN with Communications Function

- Various temperature inputs: Thermocouple, platinum resistance thermometer, infrared temperature sensor, and analog inputs.
- Auto-tuning and self-tuning available. Auto-tuning is possible even while self-tuning is being executed.
- Heating or heating/cooling control is available.
- Water-resistant construction (NEMA4X: equivalent to IP66).
- Conforms to UL, CSA, and IEC safety standards as well as CE marking.



48(W) × 24(H) × 100(D) mm



 Refer to the "Safety Precautions" on page 16.

Model Number Structure

Model Number Legend

E5GN- -

1 2 3 4 5 6

1. Output type

- R: Relay
- Q: Voltage (for driving SSR)

2. Number of alarms

- Blank: No alarm
- 1: One alarm

3. Communications

- Blank: No communications function
- 03: RS-485

4. Input type

- TC: Thermocouple
- P: Platinum resistance thermometer

5. CompoWay/F serial communications

- Blank: Not available
- FLK: CompoWay/F serial communications

6. Power supply

- AC100-240: 100 to 240 VAC
- AC/DC 24: 24 VAC/DC

Ordering Information

Standard Models

Size	Power supply voltage	No. of alarm points	Control output	Thermocouple model	Platinum resistance thermometer model
1/32 DIN 48(W) × 24(H) × 100(D) mm	100 to 240 VAC	---	Relay	E5GN-RTC AC100-240	E5GN-RP AC100-240
			Voltage (for driving SSR)	E5GN-QTC AC100-240	E5GN-QP AC100-240
		1 (see note 1)	Relay	E5GN-R1TC AC100-240	E5GN-R1P AC100-240
			Voltage (for driving SSR)	E5GN-Q1TC AC100-240	E5GN-Q1P AC100-240
	24 VAC/VDC	---	Relay	E5GN-RTC AC/DC 24	E5GN-RP AC/DC 24
			Voltage (for driving SSR)	E5GN-QTC AC/DC 24	E5GN-QP AC/DC 24
		1 (see note 1)	Relay	E5GN-R1TC AC/DC 24	E5GN-R1P AC/DC 24
			Voltage (for driving SSR)	E5GN-Q1TC AC/DC 24	E5GN-Q1P AC/DC 24

- Note 1.** If the heating/cooling function is used, ALM1 will be used for control output and so alarm output will not be available.
2. Control output 2 for heating/cooling control is relay output.
3. Specify the power supply specifications when ordering.

■ Communication Models

Size	Power supply voltage	Communication function	Control output	Thermocouple model	Platinum resistance thermometer model
1/32 DIN 48(W) × 24(H) × 100(D) mm	100 to 240 VAC	RS-485	Relay	E5GN-R03TC-FLK AC100-240	E5GN-R03P-FLK AC100-240
			Voltage (for driving SSR)	E5GN-Q03TC-FLK AC100-240	E5GN-Q03P-FLK AC100-240
	24 VAC/VDC		Relay	E5GN-R03TC-FLK AC/DC 24	E5GN-R03P-FLK AC/DC 24
			Voltage (for driving SSR)	E5GN-Q03TC-FLK AC/DC 24	E5GN-Q03P-FLK AC/DC 24

Note: Specify the power supply specifications when ordering.

Specifications

■ Ratings

Supply voltage		100 to 240 VAC, 50/60 Hz	24 VAC, 50/60 Hz/24 VDC
Operating voltage range		85% to 110% of rated supply voltage	
Power consumption		7 VA	4 VA/2.5 W
Sensor input		Thermocouple: K, J, T, E, L, U, N, R, S, B Platinum resistance thermometer: Pt100, JPt100 Infrared temperature sensor: 10 to 70°C, 60 to 120°C, 115 to 165°C, 140 to 260°C Voltage input: 0 to 50 mV	
Control output	Relay output	SPST-NO, 250 VAC, 2 A (resistive load), electrical life: 100,000 operations	
	Voltage output	12 VDC (PNP), max. load current: 21 mA, with short-circuit protection circuit	
Alarm output		SPST-NO, 250 VAC, 1 A (resistive load), electrical life: 100,000 operations	
Control method		2-PID or ON/OFF control	
Setting method		Digital setting using front panel keys	
Indication method		7-segment digital display and single-lighting indicator Character height: PV: 7.0 mm; SV: 3.5 mm	
Other functions		Multi SP, SP ramp, MV limiter, input digital filter, self-tuning, input shift, run/stop, protection functions, etc.	
Ambient temperature		-10 to 55°C (with no condensation or icing)	
Ambient humidity		25% to 85%	
Storage temperature		-25 to 65°C (with no condensation or icing)	

Input Ranges

Platinum Resistance Thermometer Input/Thermocouple Input

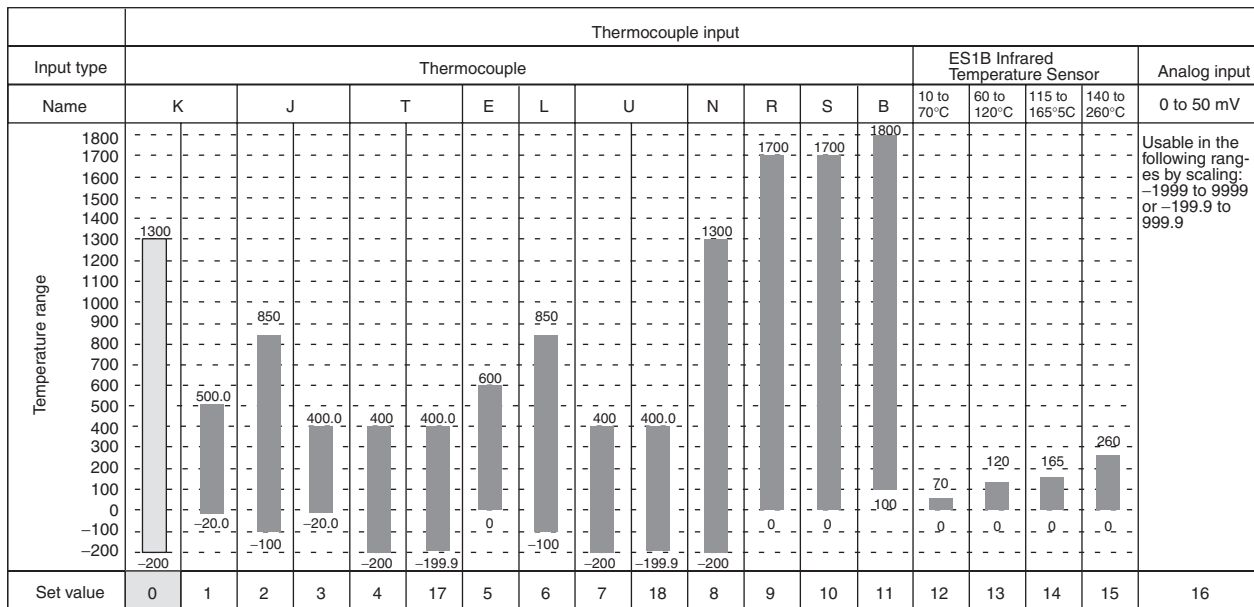
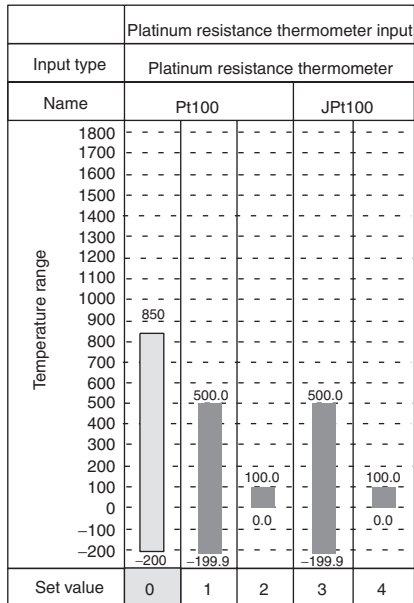

Applicable standards by input type are as follows:

- K, J, T, E, N, R, S, B: JIS C1602-1995
- L: Fe-CuNi, DIN 43710-1985
- U: Cu-CuNi, DIN 43710-1985
- JPt100: JIS C1604-1989, JIS C1606-1989
- Pt100: JIS C1604-1997, IEC751

Shaded ranges indicate default settings.

Alarm Type

For the alarm 1, select alarm types out of the 12 alarm types listed in the following table.

Set Value	Alarm Type	Alarm Output Operation	
		When X is positive	When X is negative
0	Alarm function OFF	Output OFF	
1 ^{*1}	Upper- and lower-limit (deviation)		*2
2	Upper-limit (deviation)		
3	Lower-limit (deviation)		
4 ^{*1}	Upper- and lower-limit range (deviation)		*3
5 ^{*1}	Upper- and lower-limit with standby sequence (deviation)		*4
6	Upper-limit with standby sequence (deviation)		
7	Lower-limit with standby sequence (deviation)		
8	Absolute-value upper-limit		
9	Absolute-value lower-limit		
10	Absolute-value upper-limit with standby sequence		
11	Absolute-value lower-limit with standby sequence		

*1: With set values 1, 4 and 5, the upper and lower limit values can be set independently for each alarm type, and are expressed as "L" and "H."
Following operations are for cases when an alarm set point is "X" or negative.

*2: Set value: 1, Upper- and lower-limit alarm

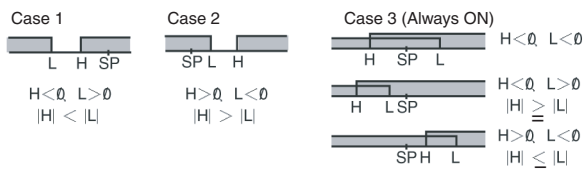

*3: Set value: 4, Upper- and lower-limit range

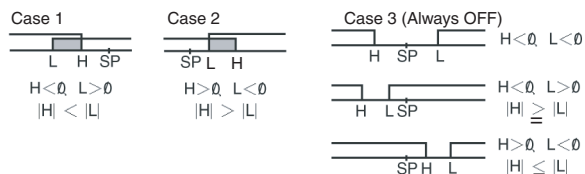

*4: Set value: 5, Upper- and lower-limit with standby sequence

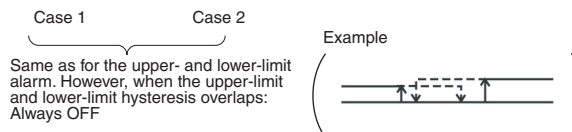

*5: Set value: 5, Upper- and lower-limit with standby sequence alarm. Always OFF when the upper-limit and lower-limit hysteresis overlaps.

Set the alarm types for alarm 1 and alarm 2 independently in the initial setting level. The default setting is 2 (upper limit). With the E5AN/E5EN, perform settings similarly for alarm 3.

Example: When the alarm is set ON at 110°C/°F or higher.

When an alarm type other than the absolute-value alarm is selected

(For alarm types 1 to 7)
The alarm value is set as a deviation from the set point.

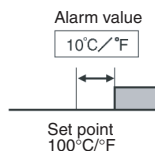

When the absolute-value alarm is selected

(For alarm types 8 to 11)
The alarm value is set as an absolute value from the alarm value of 0°C/F.

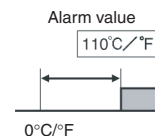

■ Characteristics

Indication accuracy	Thermocouple: (±0.5% of indicated value or ±1° C, whichever greater) ±1 digit max. (See note 1.) Platinum resistance thermometer: (±0.5% of indicated value or ±1° C, whichever greater) ±1 digit max. Analog input: ±0.5% FS±1 digit max.
Temperature variation influence (See note 2.)	Thermocouple input (R, S, B): (±1% of PV or ±10° C, whichever greater) ±1 digit max.
Voltage variation influence (See note 2.)	Other thermocouple input: (±1% of PV or ±4° C, whichever greater) ±1 digit max. K thermocouple at -100°C max.: ±10° C max. Platinum resistance thermometer: (±1% of PV or ±2° C, whichever greater) ±1 digit max. Analog input: (±1%FS) ±1 digit max.
Hysteresis	0.1 to 999.9 EU (in units of 0.1 EU)
Proportional band (P)	0.1 to 999.9 EU (in units of 0.1 EU)
Integral time (I)	0 to 3999 s (in units of 1 s)
Derivative time (D)	0 to 3999 s (in units of 1 s)
Control period	1 to 99 s (in units of 1 s)
Manual reset value	0.0% to 100.0% (in units of 0.1%)
Alarm setting range	-1999 to 9999 (decimal point position depends on input type)
Sampling period	500 ms
Insulation resistance	20 MΩ min. (at 500 VDC megger)
Dielectric strength	2000 VAC, 50 or 60 Hz for 1 min (between different charging terminals)
Vibration resistance	10 to 55 Hz, 10 m/s ² for 2 hours each in X, Y and Z directions
Shock resistance	300 m/s ² , 3 times each in 3 axes, 6 directions (relay: 100 m/s ²)
Weight	Approx. 90 g Mounting bracket: approx. 10 g
Degree of protection	Front panel: NEMA4X for indoor use (equivalent to IP66), rear case: IP20, terminals: IP00
Memory protection	EEPROM (non-volatile memory) (number of writes: 100,000)
EMC	ESD Immunity: IEC 61000-4-2: 4 kV: Contact discharge 8 kV: Air discharge Radiated Electromagnetic Field Immunity: IEC 61000-4-3 10 V/m (80 MHz to 1 GHz amplitude modulated) Burst Immunity: IEC 61000-4-4: 2 kV: Power lines 1 kV: I/O signal lines Surge Immunity: IEC 61000-4-5: 1 kV: Normal mode (power lines and output lines) 2 kV: Common mode (power lines and output lines) Conducted Disturbance Immunity: IEC 61000-4-6: 3 V: (0.16 to 80 MHz) Voltage Dip/Interrupting Immunity: IEC 61000-4-11 0.5 cycle, 100% (rated voltage) Radiated Emission: EN 61326 Class A Conducted Emission: EN 61326 Class A
Approved standards	UL 61010C-1 (Listing) CSA C22.2 No. 1010.1 (Evaluated by UL.)
Compliant standards	EN 61010-1: 2001 IEC 61010-1: 2001

Note 1. The indication of K thermocouples in the -200 to 1300° C range, and T and N thermocouples at a temperature of -100° C or less, and U and L thermocouples at any temperature is ±2° C±1 digit maximum. The indication of B thermocouples at a temperature of 400° C or less is unrestricted.

The indication of R and S thermocouples at a temperature of 200° C or less is ±3° C±1 digit maximum.

2. Ambient temperature: -10° C to 23° C to 55° C

Voltage range: -15% to +10% of rated voltage

■ Communications Specifications

Transmission path connection	Multiple points
Communications method	RS-485 (two-wire, half duplex)
Synchronization method	Start-stop synchronization
Baud rate	1,200/2,400/4,800/9,600/19,200 bps
Transmission code	ASCII
Data bit length (see note)	7 or 8 bits
Stop bit length (see note)	1 or 2 bits
Error detection	Vertical parity (none, even, odd) Frame check sequence (FCS): with SYSWAY Block check character (BCC): with CompoWay/F
Flow control	Not available
Interface (see note)	RS-485
Retry function	Not available
Communications buffer	40 bytes

Note: The baud rate, data bit length, stop bit length, or vertical parity can be individually set using the communications setting level.

Wiring Terminals

- The voltage output (control output) is not electrically insulated from the internal circuits. When using a grounding thermocouple, do not connect the control output terminals to the ground. If the control output terminals are connected to the ground, errors will occur in the measured temperature values as a result of leakage current.
- Standard insulation is applied to the power supply I/O sections. If reinforced insulation is required, connect the input and output terminals to a device without any exposed current-carrying parts or to a device with standard insulation suitable for the maximum operating voltage of the power supply I/O section.

Standard Model

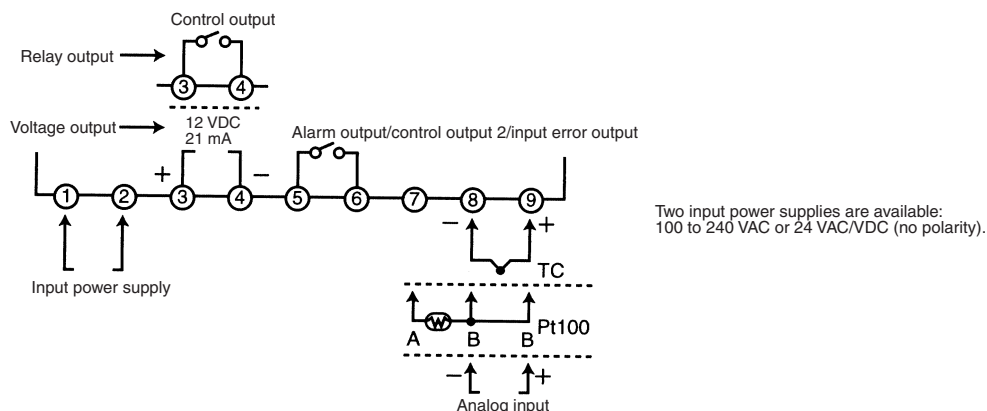

Communication Model

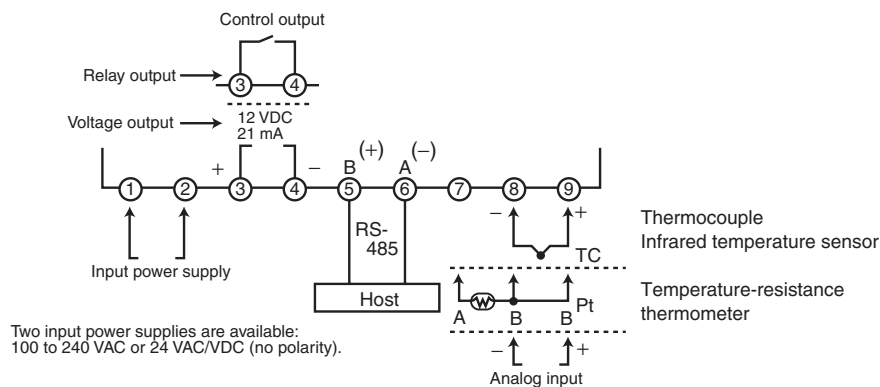

Dimensions

Note: All units are in millimeters unless otherwise indicated.

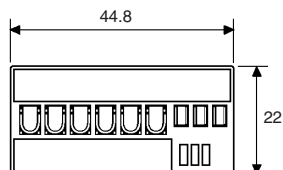
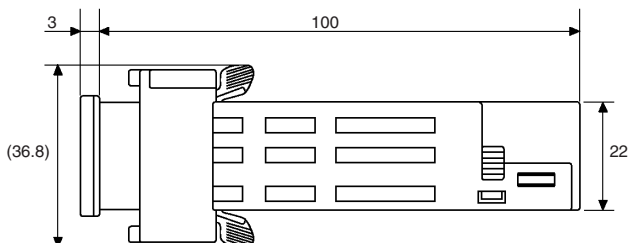
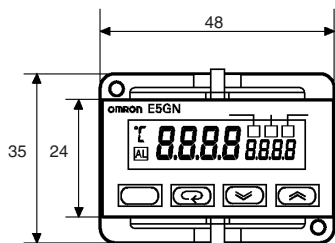
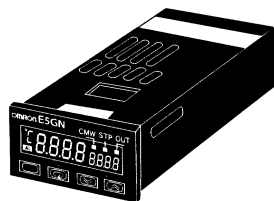

*When carrying out maintenance on the E5GN, only the terminal plate can be drawn out with the terminal leads still attached.

Panel Cutout Mounted Separately

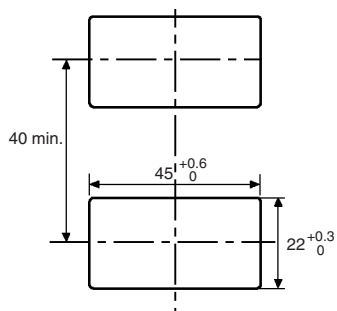

Group Mounted

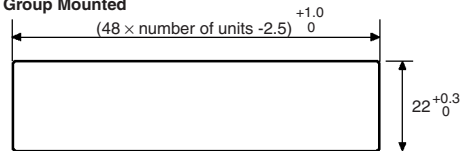

Mounting separately does not allow waterproofing.

- Insert the Controller through the hole in the panel from the front and push the adapter on from the rear. Push the adapter up to the back of the panel ensuring that the controller is pushed all the way in, removing any gap between the Controller, panel, and adapter. Finally, use the two screws on the adapter to secure the unit in place.
- To mount the E5GN so that it is waterproof, insert the waterproof packing onto the E5GN.
- When two or more E5GN Controllers are mounted, make sure that the surrounding temperature does not exceed the allowable operating temperature given in the specifications.

Nomenclature

Operation Indicators

1. AL (alarm)
Lights when alarm output is ON.
2. CMW (communications writing control)
Lights when communications writing is enabled and is out when it is disabled.
3. STP (stop)
Lights when control of the E5GN has been stopped.
During control, this indicator lights when an event or the run/stop function has been stopped. Otherwise, this indicator is out.
4. OUT (control output)
Lights when control output is ON.

Temperature Unit

The temperature unit is displayed when the display unit parameter is set to a temperature. Indication is determined by the currently selected "temperature unit" parameter set value. When this parameter is set to "°C," "°C" is displayed, and when set to "°F," "°F" is displayed.

No. 1 Display

Displays the process value or parameter type.

No. 2 Display

Displays the set point, manipulated variable or set value (setup) of the parameter.

Up Key

Each press of this key increases values displayed on the No.2 display. Holding down this key continuously increases values.

Down Key

Each press of this key decreases values displayed on the No.2 display. Holding down this key continuously decreases values.

Level + Mode Key

This key combination sets the E5GN to the "protect level."

Mode Key

Press this key to select parameters within each level.

Level Key

Press this key to select the setup level. The setup level is selected in order "operation level" ←→ "adjustment level," "initial setting level" ←→ "communications setting level."

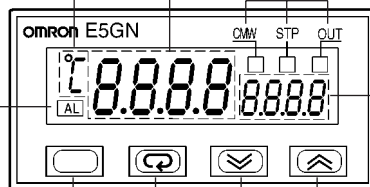

Operation

■ Specification Setting after Turning ON Power

Outline of Operation Procedures

Key Operation

In the following descriptions, all the parameters are introduced in the display sequence. Some parameters may not be displayed depending on the protect settings and operation conditions.

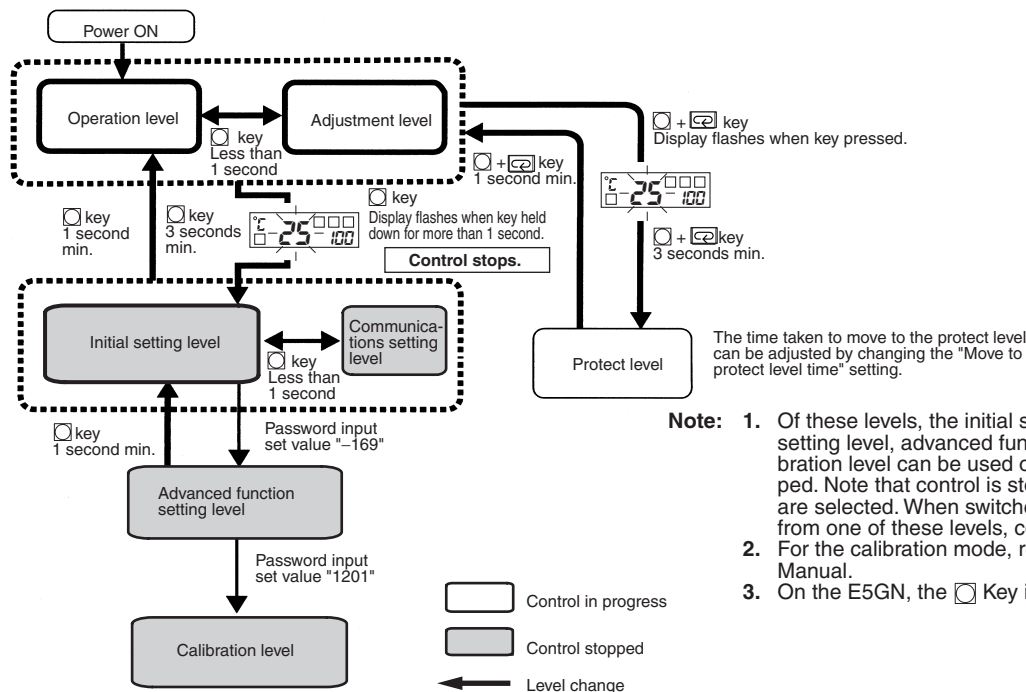

Description of Each Level

Operation Level

This level is displayed when you turn the power ON. You can move to the protect level, initial setting level and adjustment level from this level.

Normally, select this level during operation. During operation, the process value, set point and manipulated variable can be monitored, and the alarm value and upper- and lower-limit alarms can be monitored and modified.

Adjustment Level

To select this level, press the □ key once for less than one second.

This level is for entering set values and offset values for control. This level contains parameters for setting the set values, AT (auto-tuning), communications writing enable/disable, hysteresis, multi-SP, input shift values, heater burnout alarm (HBA) and PID constants. You can move to the top parameter of the operation level or initial setting level from here.

Initial Setting Level

To select this level, press the □ key for at least three seconds in the operation level. This level is for specifying the input type, selecting the control method, control period, setting direct/reverse action and alarm type. You can move to the advanced function setting level or communications setting level from this initial setting level. To return to the operation level, press the □ key for at least one second. To move to the communications setting level, press the □ key once for less than one second.

Protect Level

To select this level, simultaneously press the □ and □ keys for at least 3 seconds. This level is to prevent unwanted or accidental modification of parameters. Protected levels will not be displayed, and so the parameters in that level cannot be modified.

Communications Setting Level

To select this level, press the □ key once for less than one second in the initial setting level. When the communications function is used, set the communications conditions in this level. Communicating with a personal computer (host computer) allows set points to be read and written, and manipulated variables to be monitored.

Advanced Function Setting Level

To select this level, you must enter the password ("169") in the initial setting level.

You can move only to the calibration level from this level.

This level is for setting the automatic return of display mode, MV limiter, event input assignment, standby sequence, alarm hysteresis, ST (self-tune) and to move to the user calibration level.

Calibration Level

To select this level, you must enter the password ("1201") in the advanced function setting level. This level is for offsetting deviation in the input circuit.

You cannot move to other levels by operating the keys on the front panel from the calibration level. To cancel this level, turn the power OFF then back ON again.

Specification Setting after Turning ON Power

Initial Setting Level

This level is used for setting basic specifications of the Temperature Controller. Using this level, set the input type for selecting the input to be connected such as the thermocouple or platinum resistance thermometer and set the range of set point and the alarm mode.

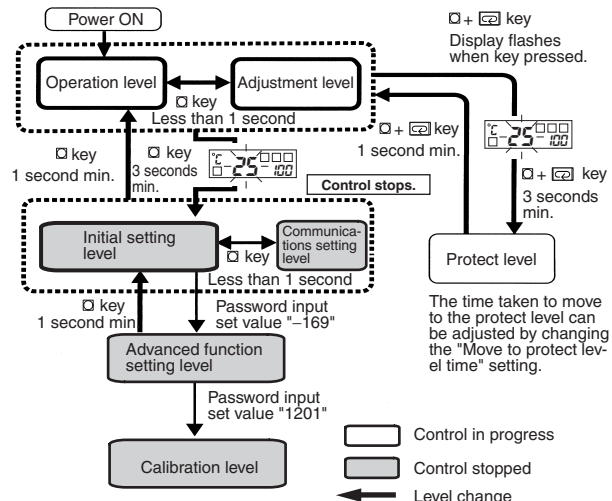

The move from the operation level to the initial setting level, press key for three seconds or more.

The initial setting level is not displayed when "initial/communications protection" is set to "2." This initial setting level can be used when "initial setting/communications protection" is set to "0" or "1."

The "scaling upper limit," "scaling lower limit," and "decimal point" parameters are displayed when an analog voltage input is selected as the input type.

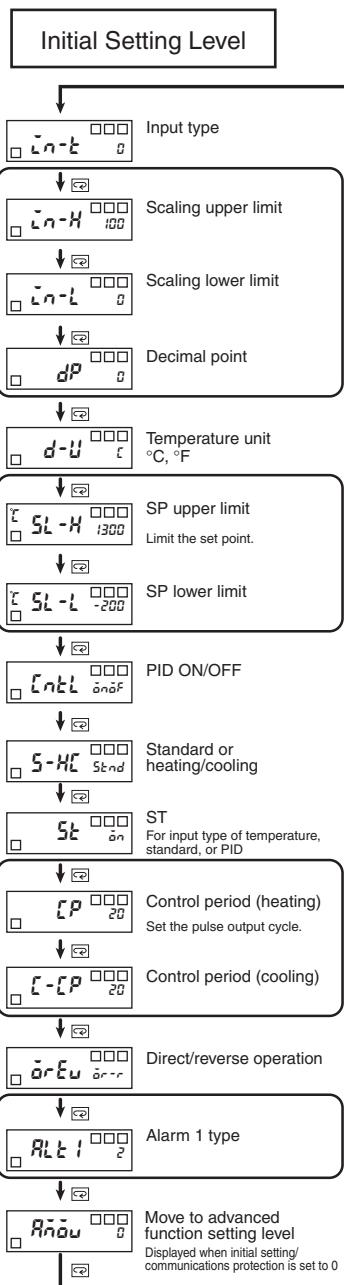

To return to the operation level, press the key for longer than one second.

Input Type

When using a thermocouple input type, follow the specifications listed in the following table.

	Input Type	Specifications	Set Value	Input Temperature Range
Thermocouple input type	Thermocouple	K	0	-200 to 1300 (°C) / -300 to 2300 (°F)
			1	-20.0 to 500.0 (°C) / 0.0 to 900.0 (°F)
		J	2	-100 to 850 (°C) / -100 to 1500 (°F)
			3	-20.0 to 400.0 (°C) / 0.0 to 750.0 (°F)
		T	4	-200 to 400 (°C) / -300 to 700 (°F)
			17	-199.9 to 400.0 (°C) / -199.9 to 700 (°F)
		E	5	0 to 600 (°C) / 0 to 1100 (°F)
		L	6	-100 to 850 (°C) / -100 to 1500 (°F)
		U	7	-200 to 400 (°C) / -300 to 700 (°F)
			18	-199.9 to 400.0 (°C) / -199.9 to 700 (°F)
		N	8	-200 to 1300 (°C) / -300 to 2300 (°F)
	R	9	0 to 1700 (°C) / 0 to 3000 (°F)	
	S	10	0 to 1700 (°C) / 0 to 3000 (°F)	
	B	11	100 to 1800 (°C) / 300 to 3200 (°F)	
	Infrared temperature sensor ES1B	10 to 70°C	12	0 to 90 (°C) / 0 to 190 (°F)
		60 to 120°C	13	0 to 120 (°C) / 0 to 240 (°F)
115 to 165°C		14	0 to 165 (°C) / 0 to 320 (°F)	
140 to 260°C		15	0 to 260 (°C) / 0 to 500 (°F)	
Analog input	0 to 50 mV	16	One of following ranges depending on the results of scaling: 1999 to 9999, 199.9 to 999.9	

Note: The initial settings are: 0: -200 to 1300°C/-300 to 2300°F.

When using the platinum resistance thermometer input type, follow the specifications listed in the following table.

	Input Type	Specifications	Set Value	Input Temperature Range
Platinum resistance thermometer input type	Platinum resistance thermometer	Pt100	0	-200 to 850 (°C) / -300 to 1500 (°F)
			1	-199.9 to 500.0 (°C) / -199.9 to 900.0 (°F)
		2	0.0 to 100.0 (°C) / 0.0 to 210.0 (°F)	
		JPt100	3	-199.9 to 500.0 (°C) / -199.9 to 900.0 (°F)
4	0.0 to 100.0 (°C) / 0.0 to 210.0 (°F)			

Note: The initial settings are: 0: Pt100 -200 to 850°C/-300 to 1500°F.

Parameters

Parameters related to setting items for each level are marked in boxes in the flowcharts and brief descriptions are given as required. At the end of each setting item, press the mode key to return to the beginning of each level.

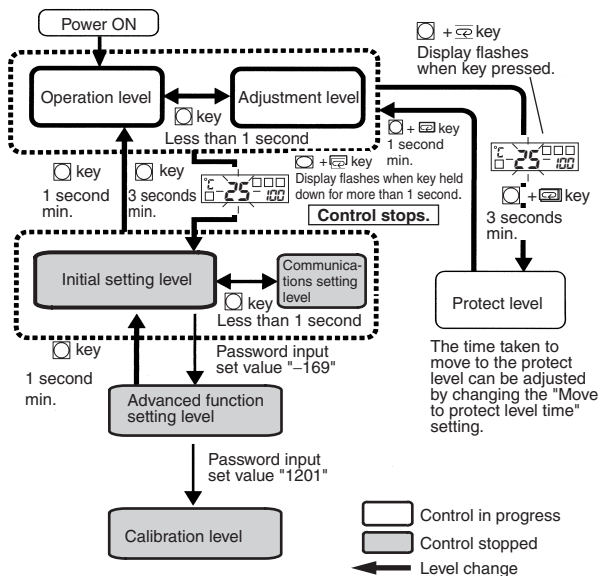

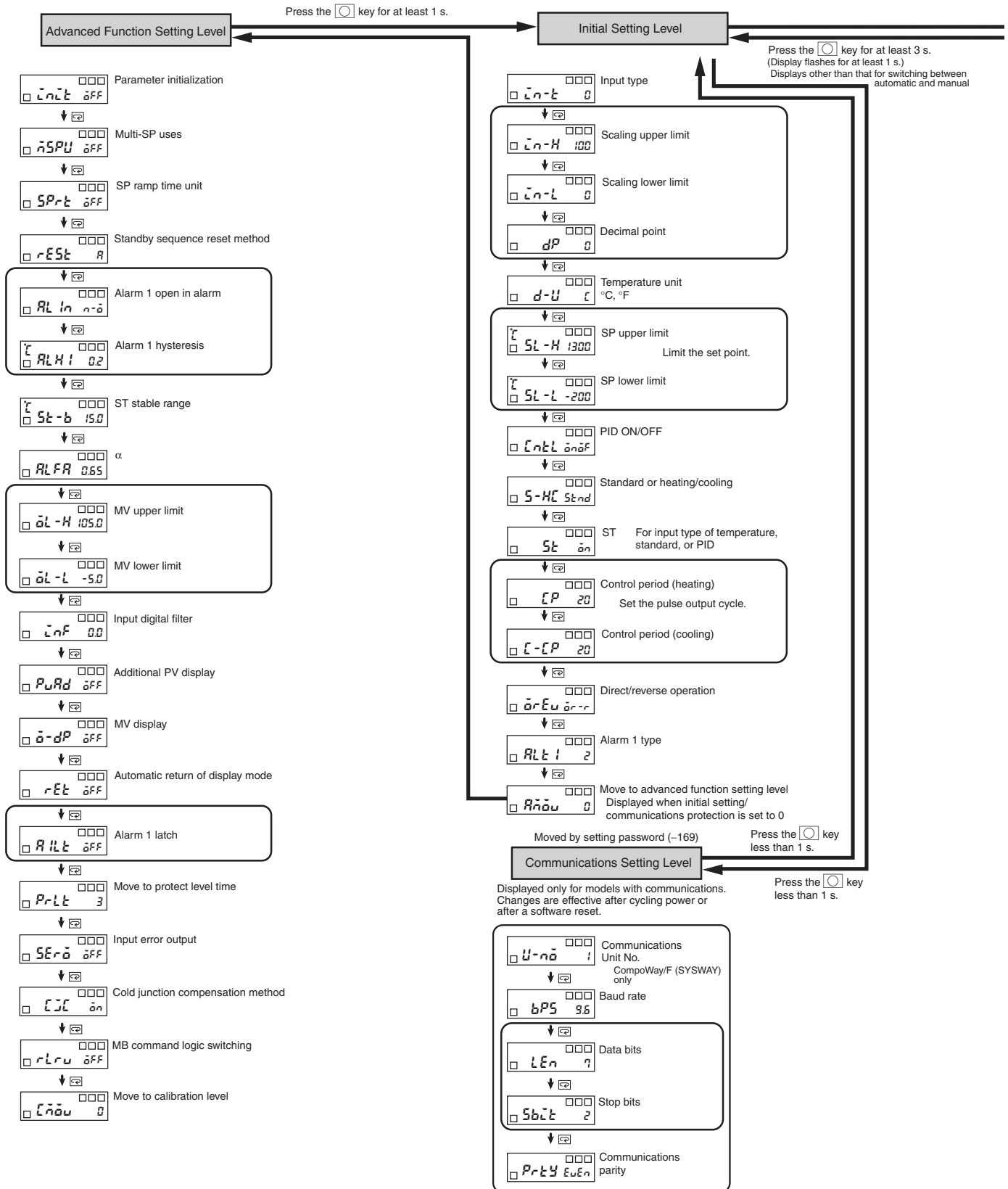

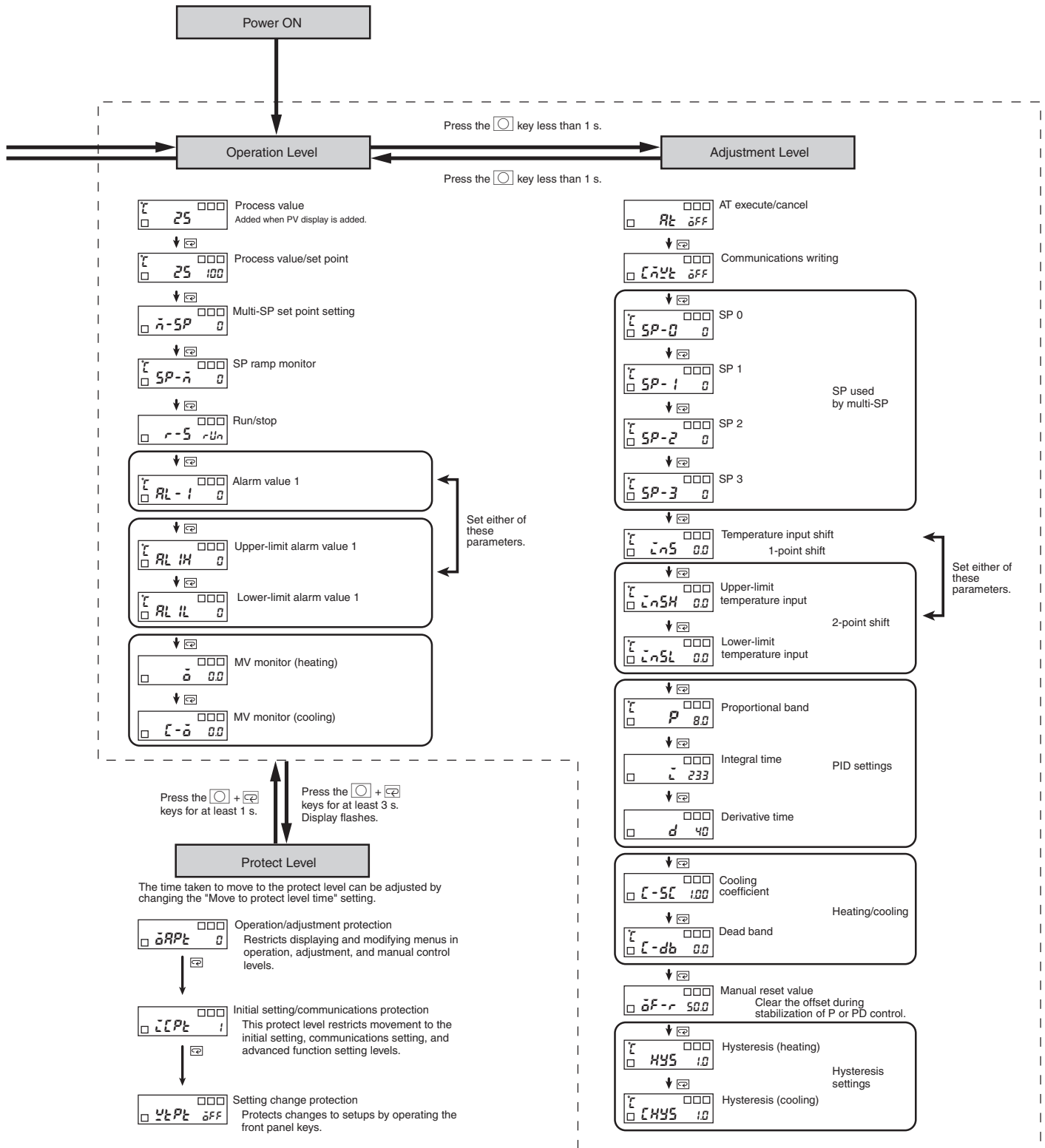

Note: These diagrams show all the parameters that may be displayed. Depending on the specifications of the model used, there may be some parameters that are not displayed.

Input Shift

All points in the sensor range are shifted by the value set as the temperature input shift value.

Example

Input shift setting	Temperature measured by sensor	Temperature display
0 (no shift)	100° C	100° C
10 (shifted +10° C)	100° C	110° C
-10 (shifted -10° C)	100° C	90° C

Protect Level

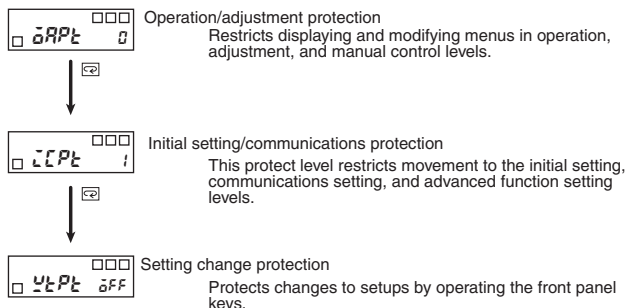

Operation/Adjustment Protection

The following table shows the relationship between set values and the range of protection.

Level		Set value			
		0	1	2	3
Operation level	PV	○	○	○	○
	PV/SP	◎	◎	◎	○
	Other	◎	◎	X	X
Adjustment level		◎	X	X	X

When this parameter is set to "0," parameters are not protected.

Default setting: 0

◎: Can be displayed and changed

○: Can be displayed

X: Cannot be displayed and move to other levels not possible

Initial Setting/Communications Protection

This protect level restricts movement to the initial setting level, communications setting level and advanced function setting level.

Set value	Initial setting level	Communication s setting level	Advanced function setting level
0	○	○	○
1	○	○	X
2	X	X	X

Default setting: 1

○: Move to other levels possible

X: Move to other levels not possible

Setting Change Protection

This protect level protects setup from being changed by operating the keys on the front panel.

Set value	Description
OFF	Setup can be changed by key operation.
ON	Setup cannot be changed by key operation. (The protect level, can be changed.)

Default setting: OFF

Communications Setting Level

Set the E5GN communications specifications in the communications setting level. For setting communications parameters, use the E5GN panel. The communications parameters and their settings are listed in the following table.

Parameter	Displayed characters	Set (monitor) value	Set value
Communications unit No.	U-nō	0 to 99	0.1 to 99
Baud rate	bP5	1.2/2.4/4.8/9.6/19.2 (kbps)	1.2/2.4/4.8/9.6/19.2
Data bits	LEn	7/8 (bit)	7/8 (bit)
Stop bits	SbLk	1/2	1/2 (bit)
Parity	P-rLk	None, even, odd	nōnE/EuEn/ōdd

Note: The highlighted values indicate default settings.

Before executing communications with the E5GN, set the communications unit No., baud rate, etc., through key operations as described below. As for other operations, refer to relevant Operation Manual.

1. Press the key for at least three seconds in the “operation level.” The level moves to the “initial setting level.”
2. Press the key for less than one second. The “initial setting level” moves to the “communications setting level.”
3. Pressing the key advances the parameters as shown in the following figure.
4. Press the or keys to change the parameter setups.

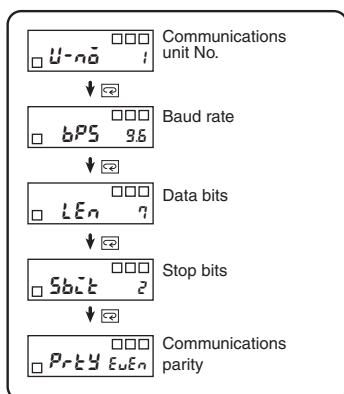

Note: On the E5GN, the Key is the Key.

Set each communications parameter to match those of the communicating personal computer.

Troubleshooting

When an error occurs, an error code will be displayed on the No. 1 display. Check the contents of an error and take appropriate countermeasures.

No.1 display	Contents	Countermeasure	Output status	
			Control output	Alarm output
SErr (S. Err)	Input error (See note.)	Check that the input wiring is correct, that there is no disconnection or short-circuit, and that the input type is correct. (Thermocouple input short-circuits cannot be detected.)	OFF	Handled as abnormally high temperature
	A/D converter error (See note.)	After noting the error, reset the power. If the display does not change, replacement is necessary. If the error is removed, it is possible that the original error was caused by noise. Check that there are no possible sources of noise.	OFF	OFF
E111 (E111)	Memory error	Reset the power. If the display does not change, replacement is necessary. If the error is removed, it is possible that the original error was caused by noise. Check that there are no possible sources of noise.	OFF	OFF
HErr (H. Err)	HB error (See note.)		OFF	OFF

Note 1. If the input is within the range for which control is possible but outside the displayable range (–1999 (–199.9) to 9999 (999.9)), will be displayed if the value is less than –1999 (–199.9), and will be displayed if it is greater than 9999 (999.9). Control output and alarm output will operate normally for either of these displays. Refer to the relevant User’s Manual for details on the ranges for which control is possible.

2. These errors are displayed only when the Controller is set to display the present value or the present value and the set value. They are not displayed in other statuses.

Communications Unit No. (U-nō)

When communicating with the host computer, the unit number must be set in each Temperature Controller so that the host computer can identify each Temperature Controller. The number can be set in a range from 0 to 99 in increments of 1. The default setting is 1. When using more than one Unit, be careful not to use the same number twice. Duplicate settings will cause malfunction. This value becomes valid when the power is turned OFF and ON again.

Baud Rate (bP5)

Use this parameter to set the speed of communications with the host computer. It can be set to one of the following values; 1.2 (1200 bps), 2.4 (2400 bps), 4.8 (4800 bps), 9.6 (9600 bps), and 19.2 (19200 bps). This setting becomes valid when the power is turned OFF and ON again.

Data Bits (LEn)

Use this parameter to change the communications data bit length to 7 bits or 8 bits.

Stop Bits (SbLk)

Use this parameter to change the communications stop bit to 1 or 2.

Communications Parity (P-rLk)

Use this parameter to set the communications parity to None, Even, or Odd.

Safety Precautions

⚠ CAUTION

Do not touch the terminals while power is being supplied. Doing so may occasionally result in minor injury due to electric shock.



Do not allow pieces of metal, wire clippings, or fine metallic shavings or filings from installation to enter the product. Doing so may occasionally result in electric shock, fire, or malfunction.



Do not use the product where subject to flammable or explosive gas. Otherwise, minor injury from explosion may occasionally occur.



Do not leave the conversion cable connected to the product. Malfunction may occur due to noise in the cable.



Do not use the Temperature Controller or Conversion Cable if it is damaged. Doing so may occasionally result in minor electric shock or fire.



Never disassemble, modify, or repair the product or touch any of the internal parts. Minor electric shock, fire, or malfunction may occasionally occur.



CAUTION - Risk of Fire and Electric Shock

- a) This product is UL listed as Open Type Process Control Equipment. It must be mounted in an enclosure that does not allow fire to escape externally.
- b) More than one disconnect switch may be required to de-energize the equipment before servicing the product.
- c) Signal inputs are SELV, limited energy. (See note 1.)
- d) Caution: To reduce the risk of fire or electric shock, do not interconnect the outputs of different Class 2 circuits. (See note 2.)



If the output relays are used past their life expectancy, contact fusing or burning may occasionally occur.

Always consider the application conditions and use the output relays within their rated load and electrical life expectancy. The life expectancy of output relays varies considerably with the output load and switching conditions.



Tighten the terminal screws properly. Tighten them to a torque of 0.24 N-m (2.5 kgf-cm) max. on terminals 1 to 6. Tighten them to a torque of 0.13 N-m (1.4 kgf-cm) max. on terminals 7 to 9. Loose screws may cause malfunction.



Set the parameters of the product so that they are suitable for the system being controlled. If they are not suitable, unexpected operation may occasionally result in property damage or accidents.



A malfunction in the product may occasionally make control operations impossible or prevent alarm outputs, resulting in property damage. To maintain safety in the event of malfunction of the product, take appropriate safety measures, such as installing a monitoring device on a separate line.



A semiconductor is used in the output section of long-life relays. If excessive noise or surge is impressed on the output terminals, a short-circuit failure is likely to occur. If the output remains shorted, fire will occur due to overheating of the heater or other cause. Take measures in the overall system to prevent excessive temperature increase and to prevent fire from spreading.



Do not allow pieces of metal or wire cuttings to get inside connectors. Failure to do so may occasionally result in minor electric shock, fire, or damage to equipment.



- Note:**
1. An SELV circuit is one separated from the power supply with double insulation or reinforced insulation, that does not exceed 30 V r.m.s. and 42.4 V peak or 60 VDC.
 2. A class 2 power supply is one tested and certified by UL as have the current and voltage of the secondary output restricted to specific levels.

Precautions for Safe Use

Be sure to observe the following precautions to prevent malfunction or adverse effects on the performance or functionality of the product. Not doing so may occasionally result in faulty operation.

- This product is specifically designed for indoor use only. Do not use this product in the following places:
 - Places directly subject to heat radiated from heating equipment.
 - Places subject to splashing liquid or oil atmosphere.
 - Places subject to direct sunlight.
 - Places subject to dust or corrosive gas (in particular, sulfide gas and ammonia gas).
 - Places subject to intense temperature change.
 - Places subject to icing and condensation.
 - Places subject to vibration and large shocks.
- Use and store the product within the rated ambient temperature and humidity. Gang-mounting two or more Temperature Controllers, or mounting Temperature Controllers above each other may cause heat to build up inside the Temperature Controllers, which will shorten their service life. In such a case, use forced cooling by fans or other means of air ventilation to cool down the Temperature Controllers.
- To allow heat to escape, do not block the area around the product. Do not block the ventilation holes on the product.
- Be sure to wire properly with correct polarity of terminals.
- Use the specified size (M3.5, width 7.2 mm or less) crimped terminals for wiring. To connect bare wires to the terminal block, use stranded or solid copper wires with a gage of AWG24 to AWG14 (equal to a cross-sectional area of 0.205 to 2.081 mm²). (The stripping length is 5 to 6 mm.) Up to two wires or two crimp terminals can be inserted into a single terminal.
- Do not wire the terminals that are not used.
- To avoid inductive noise, keep the wiring for the product's terminal block away from power cables carry high voltages or large currents. Also, do not wire power lines together with or parallel to product wiring. Using shielded cables and using separate conduits or ducts is recommended. Attach a surge suppressor or noise filter to peripheral devices that generate noise (in particular, motors, transformers, solenoids, magnetic coils, or other equipment that have an inductance component). When a noise filter is used at the power supply, first check the voltage or current, and attach the noise filter as close as possible to the product. Allow as much space as possible between the product and devices that generate powerful high frequencies (high-frequency welders, high-frequency sewing machines, etc.) or surge.
- Use this product within the rated load and power supply.
- Make sure that the rated voltage is attained within two seconds of turning ON the power using a switch or relay contact. If the voltage is applied gradually, the power may not be reset or output malfunctions may occur.
- Make sure that the Temperature Controller has 30 minutes or more to warm up after turning ON the power before starting actual control operations to ensure the correct temperature display.
- When executing self-tuning, turn ON power to the load (e.g., heater) at the same time as or before supplying power to the product. If power is turned ON to the product before turning ON power to the load, self-tuning will not be performed properly and optimum control will not be achieved.
- A switch or circuit breaker must be provided close to the product. The switch or circuit breaker must be within easy reach of the operator, and must be marked as a disconnecting means for this unit.
- Always turn OFF the power supply before pulling out the interior of the product, and never touch nor apply shock to the terminals or electronic components. When inserting the interior of the product, do not allow the electronic components to touch the case.
- Do not use paint thinner or similar chemical to clean with. Use standard grade alcohol.

- Design the system (e.g., control panel) considering the 2 seconds of delay that the product's output to be set after power ON.
- The output may turn OFF when shifting to certain levels. Take this into consideration when performing control.
- The EEPROM has a limited write life. When overwriting data frequently, e.g., via communications, use RAM Mode.

Precautions for Correct Use

Service Life

- Use the product within the following temperature and humidity ranges:
 - Temperature: -10 to 55°C (with no icing or condensation)
 - Humidity: 25% to 85%
 If the product is installed inside a control board, the ambient temperature must be kept to under 55°C, including the temperature around the product.
- The service life of electronic devices like Temperature Controllers is determined not only by the number of times the relay is switched but also by the service life of internal electronic components. Component service life is affected by the ambient temperature: the higher the temperature, the shorter the service life and, the lower the temperature, the longer the service life. Therefore, the service life can be extended by lowering the temperature of the Temperature Controller.
- When two or more Temperature Controllers are mounted horizontally close to each other or vertically next to one another, the internal temperature will increase due to heat radiated by the Temperature Controllers and the service life will decrease. In such a case, use forced cooling by fans or other means of air ventilation to cool down the Temperature Controllers. When providing forced cooling, however, be careful not to cool down the terminals sections alone to avoid measurement errors.

Measurement Accuracy

- When extending or connecting the thermocouple lead wire, be sure to use compensating wires that match the thermocouple types.
- When extending or connecting the lead wire of the platinum resistance thermometer, be sure to use wires that have low resistance and keep the resistance of the three lead wires the same.
- Mount the product so that it is horizontally level.
- If the measurement accuracy is low, check to see if input shift has been set correctly.

Waterproofing

The degree of protection is as shown below. Sections without any specification on their degree of protection or those with IP□0 are not waterproof.

Front panel: NEMA4X for indoor use (equivalent to IP66)
Rear case: IP20, Terminal section: IP00

Operating Precautions

- It takes approximately two seconds for the outputs to turn ON from after the power supply is turned ON. Due consideration must be given to this time when incorporating Temperature Controllers in a sequence circuit.
- When using self-tuning, turn ON power for the load (e.g., heater) at the same time as or before supplying power to the Temperature Controller. If power is turned ON for the Temperature Controller before turning ON power for the load, self-tuning will not be performed properly and optimum control will not be achieved.
- When starting operation after the Temperature Controller has warmed up, turn OFF the power and then turn it ON again at the same time as turning ON power for the load. (Instead of turning the Temperature Controller OFF and ON again, switching from STOP mode to RUN mode can also be used.)

4. Avoid using the Controller in places near a radio, television set, or wireless installing. These devices can cause radio disturbances which adversely affect the performance of the Controller.

Mounting

1. Insert the E5GN into the mounting hole in the panel from the front.
2. Push the adapter along the E5GN body from the terminals up to the panel, and secure it temporarily.
3. Tighten the two fixing screws on the adapter. When tightening screws, tighten the two screws alternately keeping the torque to within approximately 0.29 to 0.39 N·m.

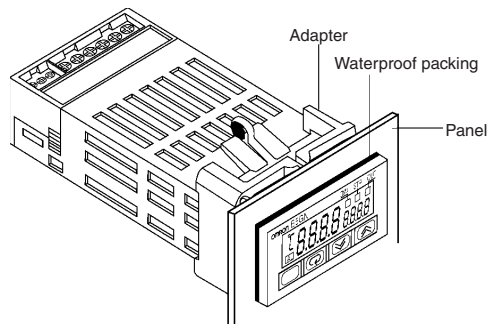

Removing and Attaching the Terminal Plate

The E5GN can be replaced by removing the terminal plate.

1. Press down hard on the fasteners on both sides of the terminals to unlock the terminal plate and pull upwards.

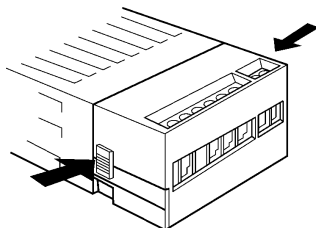

2. Draw out the terminal plate as it is.

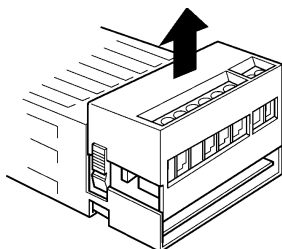

3. Before you insert the terminal plate again, make sure that the pins match the positions of the holes in the terminal plate.

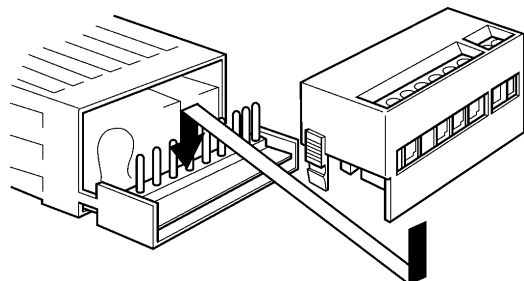

Wiring Precautions

- Connect the terminals as specified below.

Terminal No.	Cables	Pin terminals
1 to 6	AWG24 to AWG14	2.1 dia. max.
7 to 9	AWG28 to AWG22	1.3 dia. max.

- The exposed current-carrying part to be inserted into terminals must be 5 to 6 mm.

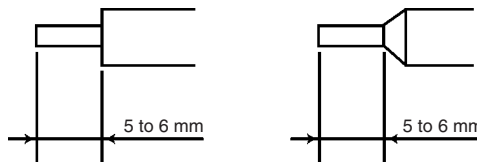

Electrical wire

Pin terminal

- Tighten the terminal screws to the torque specified below.

Terminal No.	Screw	Maximum tightening torque
1 to 6	M2.6	0.23 to 0.25 N·m
7 to 9	M2	0.12 to 0.14 N·m

Terms and Conditions of Sale

- Offer: Acceptance.** These terms and conditions (these "Terms") are deemed part of all quotes, agreements, purchase orders, acknowledgments, price lists, catalogs, manuals, brochures and other documents, whether electronic or in writing, relating to the sale of products or services (collectively, the "Products") by Omron Electronics LLC and its subsidiary companies ("Omron"). Omron objects to any terms or conditions proposed in Buyer's purchase order or other documents which are inconsistent with, or in addition to, these Terms.
- Prices: Payment Terms.** All prices stated are current, subject to change without notice by Omron. Omron reserves the right to increase or decrease prices on any unshipped portions of outstanding orders. Payments for Products are due net 30 days unless otherwise stated in the invoice.
- Discounts.** Cash discounts, if any, will apply only on the net amount of invoices sent to Buyer after deducting transportation charges, taxes and duties, and will be allowed only if (i) the invoice is paid according to Omron's payment terms and (ii) Buyer has no past due amounts.
- Interest.** Omron, at its option, may charge Buyer 1-1/2% interest per month or the maximum legal rate, whichever is less, on any balance not paid within the stated terms.
- Orders.** Omron will accept no order less than \$200 net billing.
- Governmental Approvals.** Buyer shall be responsible for, and shall bear all costs involved in, obtaining any government approvals required for the importation or sale of the Products.
- Taxes.** All taxes, duties and other governmental charges (other than general real property and income taxes), including any interest or penalties thereon, imposed directly or indirectly on Omron or required to be collected directly or indirectly by Omron for the manufacture, production, sale, delivery, importation, consumption or use of the Products sold hereunder (including customs duties and sales, excise, use, turnover and license taxes) shall be charged to and remitted by Buyer to Omron.
- Financial.** If the financial position of Buyer at any time becomes unsatisfactory to Omron, Omron reserves the right to stop shipments or require satisfactory security or payment in advance. If Buyer fails to make payment or otherwise comply with these Terms or any related agreement, Omron may (without liability and in addition to other remedies) cancel any unshipped portion of Products sold hereunder and stop any Products in transit until Buyer pays all amounts, including amounts payable hereunder, whether or not then due, which are owing to it by Buyer. Buyer shall in any event remain liable for all unpaid accounts.
- Cancellation: Etc.** Orders are not subject to rescheduling or cancellation unless Buyer indemnifies Omron against all related costs or expenses.
- Force Majeure.** Omron shall not be liable for any delay or failure in delivery resulting from causes beyond its control, including earthquakes, fires, floods, strikes or other labor disputes, shortage of labor or materials, accidents to machinery, acts of sabotage, riots, delay in or lack of transportation or the requirements of any government authority.
- Shipping: Delivery.** Unless otherwise expressly agreed in writing by Omron:
 - Shipments shall be by a carrier selected by Omron; Omron will not drop ship except in "break down" situations.
 - Such carrier shall act as the agent of Buyer and delivery to such carrier shall constitute delivery to Buyer;
 - All sales and shipments of Products shall be FOB shipping point (unless otherwise stated in writing by Omron), at which point title and risk of loss shall pass from Omron to Buyer; provided that Omron shall retain a security interest in the Products until the full purchase price is paid;
 - Delivery and shipping dates are estimates only; and
 - Omron will package Products as it deems proper for protection against normal handling and extra charges apply to special conditions.
- Claims.** Any claim by Buyer against Omron for shortage or damage to the Products occurring before delivery to the carrier must be presented in writing to Omron within 30 days of receipt of shipment and include the original transportation bill signed by the carrier noting that the carrier received the Products from Omron in the condition claimed.
- Warranties.** (a) **Exclusive Warranty.** Omron's exclusive warranty is that the Products will be free from defects in materials and workmanship for a period of twelve months from the date of sale by Omron (or such other period expressed in writing by Omron). Omron disclaims all other warranties, express or implied. (b) **Limitations.** OMRON MAKES NO WARRANTY OR REPRESENTATION, EXPRESS OR IMPLIED, ABOUT NON-INFRINGEMENT, MERCHANTABILITY OR FITNESS FOR A PARTICULAR PURPOSE OF THE PRODUCTS. BUYER ACKNOWLEDGES THAT IT ALONE HAS DETERMINED THAT THE PRODUCTS WILL SUITABLY MEET THE REQUIREMENTS OF THEIR INTENDED USE. Omron further disclaims all warranties and responsibility of any type for claims or expenses based on infringement by the Products or otherwise of any intellectual property right. (c) **Buyer Remedy.** Omron's sole obligation hereunder shall be, at Omron's election, to (i) replace (in the form originally shipped with Buyer responsible for labor charges for removal or replacement thereof) the non-complying Product, (ii) repair the non-complying Product, or (iii) repay or credit Buyer an amount equal to the purchase price of the non-complying Product; provided that in no event shall Omron be responsible for warranty, repair, indemnity or any other claims or expenses regarding the Products unless Omron's analysis confirms that the Products were properly handled, stored, installed and maintained and not subject to contamination, abuse, misuse or inappropriate modification. Return of any Products by Buyer must be approved in writing by Omron before shipment. Omron Companies shall not be liable for the suitability or unsuitability or the results from the use of Products in combination with any electrical or electronic components, circuits, system assemblies or any other materials or substances or environments. Any advice, recommendations or information given orally or in writing, are not to be construed as an amendment or addition to the above warranty. See <http://oeweb.omron.com> or contact your Omron representative for published information.
- Limitation on Liability: Etc.** OMRON COMPANIES SHALL NOT BE LIABLE FOR SPECIAL, INDIRECT, INCIDENTAL, OR CONSEQUENTIAL DAMAGES, LOSS OF PROFITS OR PRODUCTION OR COMMERCIAL LOSS IN ANY WAY CONNECTED WITH THE PRODUCTS, WHETHER SUCH CLAIM IS BASED IN CONTRACT, WARRANTY, NEGLIGENCE OR STRICT LIABILITY. Further, in no event shall liability of Omron Companies exceed the individual price of the Product on which liability is asserted.
- Indemnities.** Buyer shall indemnify and hold harmless Omron Companies and their employees from and against all liabilities, losses, claims, costs and expenses (including attorney's fees and expenses) related to any claim, investigation, litigation or proceeding (whether or not Omron is a party) which arises or is alleged to arise from Buyer's acts or omissions under these Terms or in any way with respect to the Products. Without limiting the foregoing, Buyer (at its own expense) shall indemnify and hold harmless Omron and defend or settle any action brought against such Companies to the extent based on a claim that any Product made to Buyer specifications infringed intellectual property rights of another party.
- Property: Confidentiality.** Any intellectual property in the Products is the exclusive property of Omron Companies and Buyer shall not attempt to duplicate it in any way without the written permission of Omron. Notwithstanding any charges to Buyer for engineering or tooling, all engineering and tooling shall remain the exclusive property of Omron. All information and materials supplied by Omron to Buyer relating to the Products are confidential and proprietary, and Buyer shall limit distribution thereof to its trusted employees and strictly prevent disclosure to any third party.
- Export Controls.** Buyer shall comply with all applicable laws, regulations and licenses regarding (i) export of products or information; (ii) sale of products to "forbidden" or other proscribed persons; and (iii) disclosure to non-citizens of regulated technology or information.
- Miscellaneous.** (a) **Waiver.** No failure or delay by Omron in exercising any right and no course of dealing between Buyer and Omron shall operate as a waiver of rights by Omron. (b) **Assignment.** Buyer may not assign its rights hereunder without Omron's written consent. (c) **Law.** These Terms are governed by the law of the jurisdiction of the home office of the Omron company from which Buyer is purchasing the Products (without regard to conflict of law principles). (d) **Amendment.** These Terms constitute the entire agreement between Buyer and Omron relating to the Products, and no provision may be changed or waived unless in writing signed by the parties. (e) **Severability.** If any provision hereof is rendered ineffective or invalid, such provision shall not invalidate any other provision. (f) **Setoff.** Buyer shall have no right to set off any amounts against the amount owing in respect of this invoice. (g) **Definitions.** As used herein, "including" means "including without limitation"; and "Omron Companies" (or similar words) mean Omron Corporation and any direct or indirect subsidiary or affiliate thereof.

Certain Precautions on Specifications and Use

- Suitability of Use.** Omron Companies shall not be responsible for conformity with any standards, codes or regulations which apply to the combination of the Product in the Buyer's application or use of the Product. At Buyer's request, Omron will provide applicable third party certification documents identifying ratings and limitations of use which apply to the Product. This information by itself is not sufficient for a complete determination of the suitability of the Product in combination with the end product, machine, system, or other application or use. Buyer shall be solely responsible for determining appropriateness of the particular Product with respect to Buyer's application, product or system. Buyer shall take application responsibility in all cases but the following is a non-exhaustive list of applications for which particular attention must be given:
 - Outdoor use, uses involving potential chemical contamination or electrical interference, or conditions or uses not described in this document.
 - Use in consumer products or any use in significant quantities.
 - Energy control systems, combustion systems, railroad systems, aviation systems, medical equipment, amusement machines, vehicles, safety equipment, and installations subject to separate industry or government regulations.
 - Systems, machines and equipment that could present a risk to life or property. Please know and observe all prohibitions of use applicable to this Product. NEVER USE THE PRODUCT FOR AN APPLICATION INVOLVING SERIOUS RISK TO LIFE OR PROPERTY OR IN LARGE QUANTITIES WITHOUT ENSURING THAT THE SYSTEM AS A WHOLE HAS BEEN DESIGNED TO ADDRESS THE RISKS, AND THAT THE OMRON'S PRODUCT IS PROPERLY RATED AND INSTALLED FOR THE INTENDED USE WITHIN THE OVERALL EQUIPMENT OR SYSTEM.
- Programmable Products.** Omron Companies shall not be responsible for the user's programming of a programmable Product, or any consequence thereof.
- Performance Data.** Data presented in Omron Company websites, catalogs and other materials is provided as a guide for the user in determining suitability and does not constitute a warranty. It may represent the result of Omron's test conditions, and the user must correlate it to actual application requirements. Actual performance is subject to the Omron's Warranty and Limitations of Liability.
- Change in Specifications.** Product specifications and accessories may be changed at any time based on improvements and other reasons. It is our practice to change part numbers when published ratings or features are changed, or when significant construction changes are made. However, some specifications of the Product may be changed without any notice. When in doubt, special part numbers may be assigned to fix or establish key specifications for your application. Please consult with your Omron's representative at any time to confirm actual specifications of purchased Product.
- Errors and Omissions.** Information presented by Omron Companies has been checked and is believed to be accurate; however, no responsibility is assumed for clerical, typographical or proofreading errors or omissions.

Complete "Terms and Conditions of Sale" for product purchase and use are on Omron's website at www.omron.com/oei – under the "About Us" tab, in the Legal Matters section.

ALL DIMENSIONS SHOWN ARE IN MILLIMETERS.

To convert millimeters into inches, multiply by 0.03937. To convert grams into ounces, multiply by 0.03527.



OMRON ELECTRONICS LLC

One Commerce Drive
Schaumburg, IL 60173

847-843-7900

For US technical support or other inquiries:

800-556-6766

OMRON CANADA, INC.

885 Milner Avenue
Toronto, Ontario M1B 5V8

416-286-6465

OMRON ON-LINE

Global - <http://www.omron.com>
USA - <http://www.omron.com/oei>
Canada - <http://www.omron.ca>